

ZYH-X系列高插入损耗EMI电源滤波器
ZYH-X series high insertion losses EMI filter

X系列 : X Series



X系列 : X Series

特点和应用: Features and Applications

在很宽的频带范围内具有极高的共模和差模插入损耗
Very high differential and common mode attenuation

对连续或间歇性干扰具有较高的抑制作用
High suppression for continuous and intermittent pulse interference

计价的高频干扰抑制特性

Good high frequency attenuation

适用于各种电子和数字设备（尤其是开关电源）
Available for various digital systems (partially for switching power supplies)

订购信息: Ordering Information

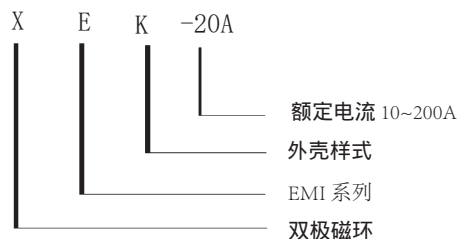

规格: Specifications

每条线路对地的最大泄漏电流:

Maximum leakage current each Line to Ground:











	XEK	XER	XEY	XEU/XEJ
@ 120 VAC 60 Hz:	≤1.5mA	≤2.0mA	≤3.5mA	≤5.0mA
@ 250 VAC 50 Hz:	≤2.0mA	≤3.5 mA	≤5.0mA	≤7.5mA

Hipot额定值 (一分钟):

Hipot rating (one minute):

线路对地: Line to Ground:	1800VAC
线对线: Line to Line:	1500VDC
工作电压: Rated Voltage (max.):	250VAC
工作频率: Operating Frequency:	50/60HZ
额定电流: Rated Current:	10 - 200A

可选型号 Available Part Numbers

型号 Type	额定电流范围 Rated Current (A)	绝缘电阻 Insulation Resistance	端接方式 Terminal	
			入Input	出Output
ZYH-XEK	10 - 20	≥500		
ZYH-XER	10 - 30	≥500		
ZYH-XEY	40 - 60	≥500		
ZYH-XEU	50 - 100	≥500		
ZYH-XEJ	80 - 300	≥500		

电路原理图 Electrical Schematics

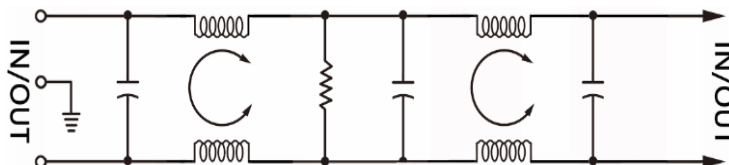

ZYH-X系列高插入损耗EMI电源滤波器
ZYH-X series high insertion losses EMI filter

X系列 : X Series

XEK外壳样式 : XEK Case Styles

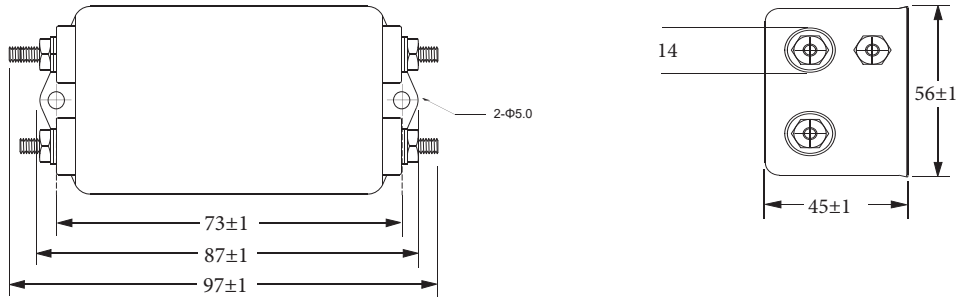

XER外壳样式 : XER Case Styles

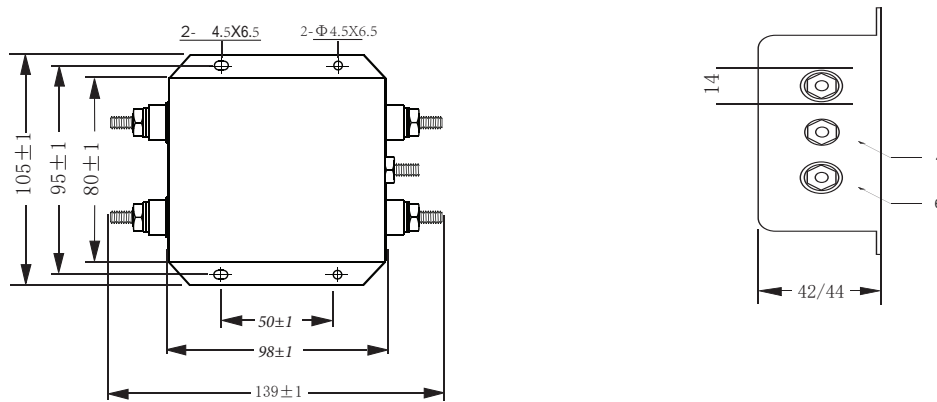

XEY外壳样式 : XEY Case Styles

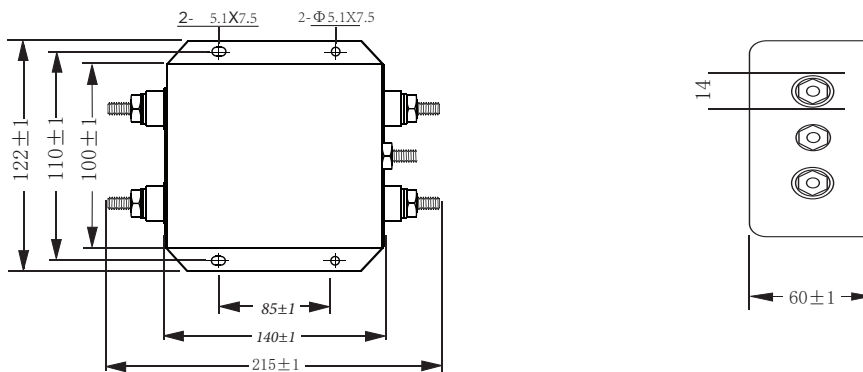

ZYH-X系列高插入损耗EMI电源滤波器
ZYH-X series high insertion losses EMI filter

XEU外壳样式：XEU Case Styles

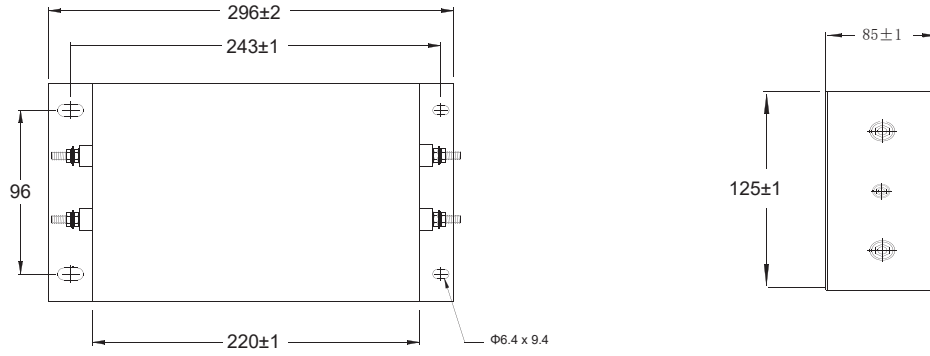

XEJ外壳样式：XEJ Case Styles

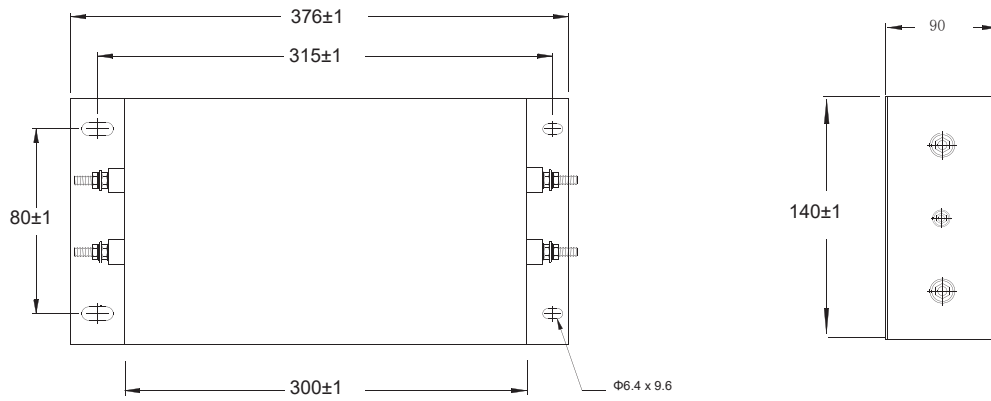

ZYH-X系列高插入损耗EMI电源滤波器
ZYH-X series high insertion losses EMI filter

X系列 : X Series

性能参数



Performance Data

典型插入损耗

Typical Insertion Loss

在封闭的50欧姆系统中测量

Measured in closed 50 Ohm system

 共模/不对称 (L-G)
Common Mode / Asymmetrical (L-G)
 差模/对称 (L-L)
Differential Mode / Symmetrical (L-L)

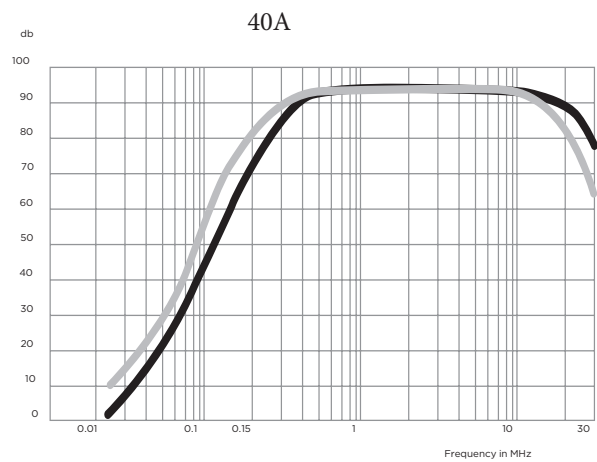
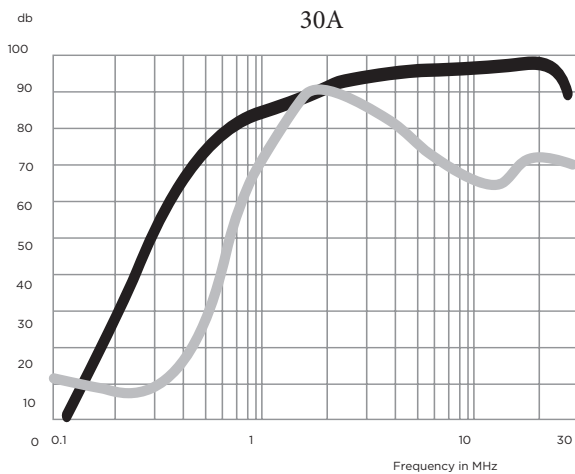
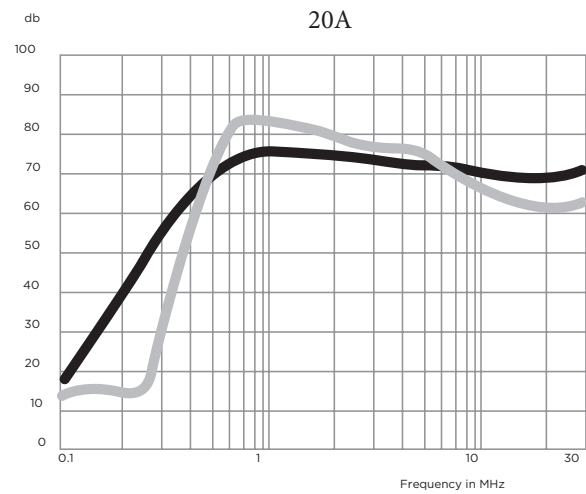
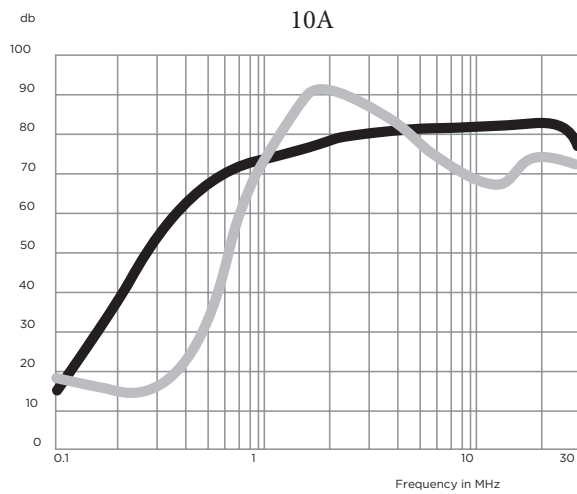

ZYH-X系列高插入损耗EMI电源滤波器
ZYH-X series high insertion losses EMI filter

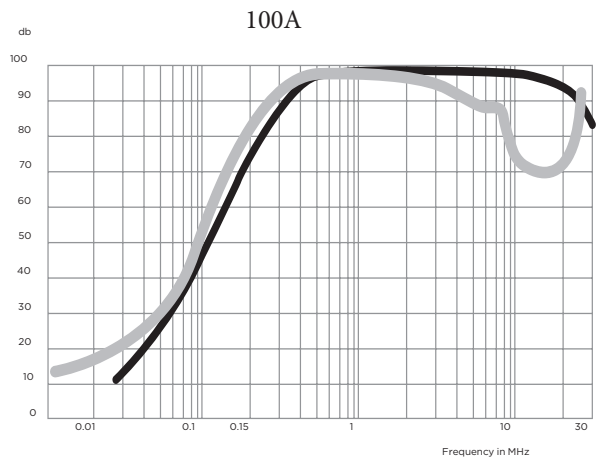
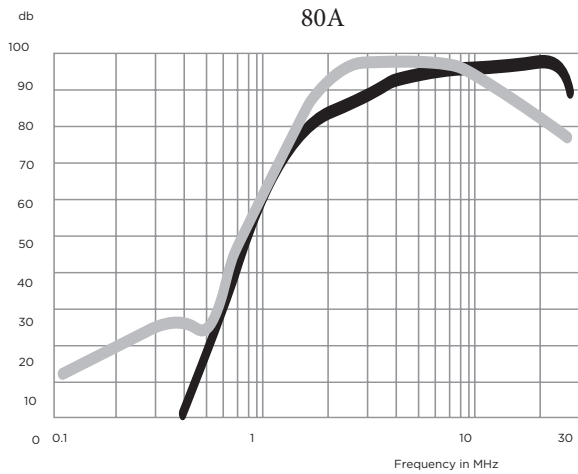
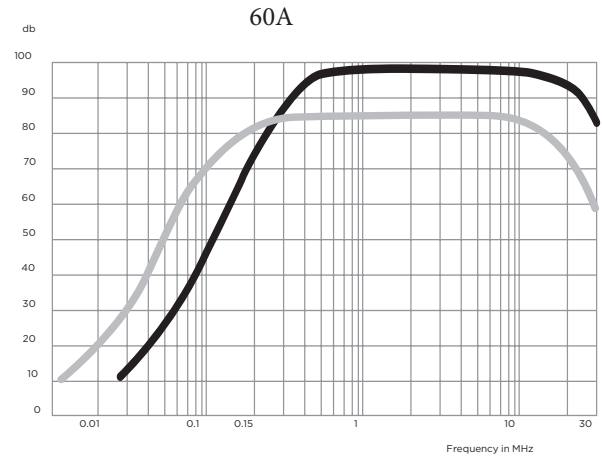
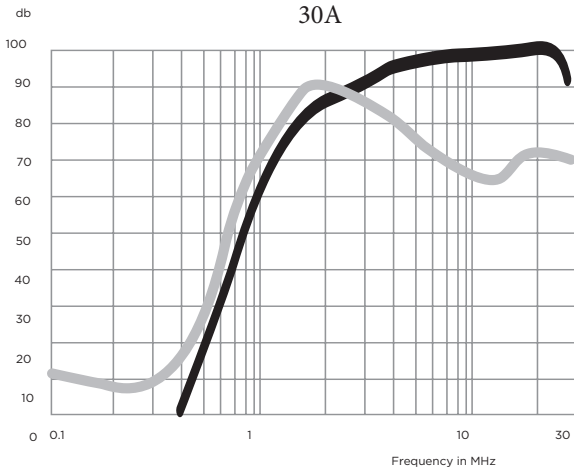

最小插入损耗 Minimum Insertion Loss

共模/不对称 (线对地)
Common Mode / Asymmetrical (Line to Ground)

Current Rating	Frequency – MHz					
	.15	.5	1	5	10	30
10A	30	65	65	65	81	77
20A	5	44	60	65	71	73
30A	-	-	60	65	100	90
60A	-	-	60	95	100	90
80A	-	-	70	85	92	88
100A	-	-	100	96	93	83

差模/对称 (线对线)
Differential Mode / Symmetrical (Line to Line)

Current Rating	Frequency – MHz					
	.15	.5	1	5	10	30
10A	-	-	65	60	69	72
20A	-	-	35	60	66	63
30A	-	-	65	60	69	73
60A	-	-	100	96	93	86
80A	-	-	60	85	93	88
100A	-	-	100	90	82	93