

ZYH-B系列军工EMI电源滤波器
ZYH-B series military EMI filter

B系列 : B Series



B系列 : B Series

特点和应用: Features and Applications

在全频段内对共模和差模干扰均具有良好的抑制效果协助您的产品满足GJB151A-97标准要求

Provide good performance of suppressing both CM and DM of all frequency

对电源线上的10KHz以上的干扰具有良好的抑制作用
Provide effective suppression for frequency above 10KHz in line







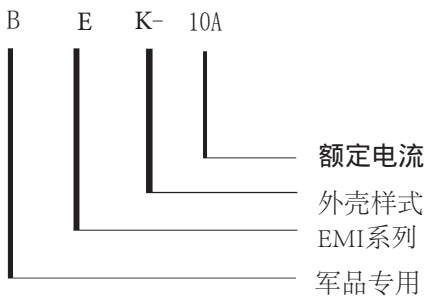







适用于含有开关电源、数字电路以及易受干扰的军用设备

Available for various digital systems (particularly for switching power supplies)

订购信息: Ordering Information



可选型号 Available Part Numbers

型号 Type ZYH-	额定电流范围 Rated Current (A)	绝缘电阻 Insulation Resistance	端接方式 Terminal	
			入Input	出Output
BEK	10 - 30	≥ 1500		
BES	10 - 30	≥ 1500		
BER	10 - 30	≥ 1500		
BED	20 - 60	≥ 1500		
BEY	40 - 60	≥ 1500		
BEU	50 - 100	≥ 1500		
BEJ	80 - 300	≥ 1500		

规格: Specifications

每条线路对地的最大泄漏电流:

Maximum leakage current each Line to Ground:

	BEK/BES/BER	BED	BEY/BEU	BEJ
@ 120 VAC 60 Hz:	≤ 1.6mA	≤ 2.5mA	≤ 4.0mA	≤ 6.0mA
@ 250 VAC 50 Hz:	≤ 2.0mA	≤ 3.0mA	≤ 5.0mA	≤ 8.0mA

Hipot额定值 (一分钟):

Hipot rating (one minute):

线路对地: Line to Ground:	2000VDC
线对线: Line to Line:	1800VDC
工作电压: Rated Voltage (max.):	250VAC
工作频率: Operating Frequency:	50/60HZ
额定电流: Rated Current:	10 - 100A

电路原理图 Electrical Schematics

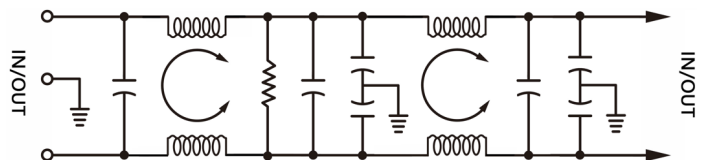

ZYH-B系列军工EMI电源滤波器
ZYH-B series military EMI filter

B系列：B Series

外壳样式：Case Styles

BEK外壳样式：BEK Case Styles

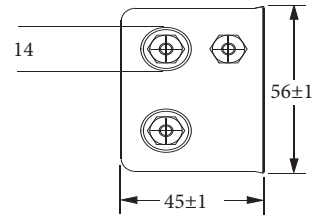
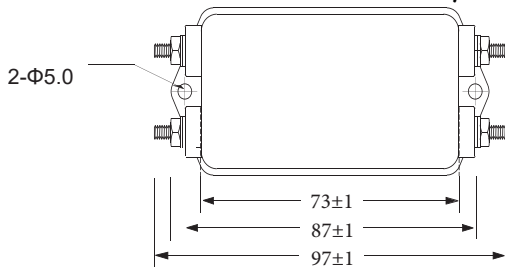

BES外壳样式：BES Case Styles

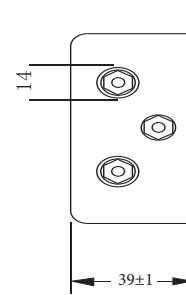
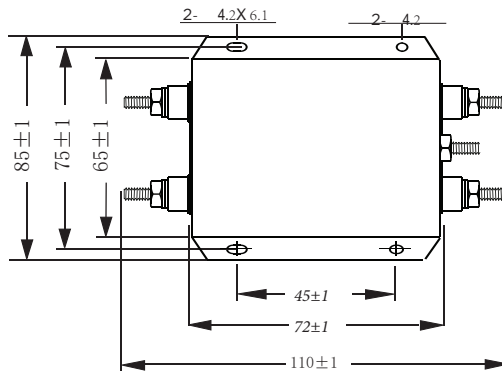

BER外壳样式：BER Case Styles

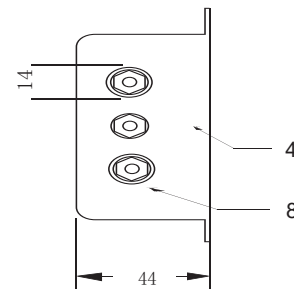
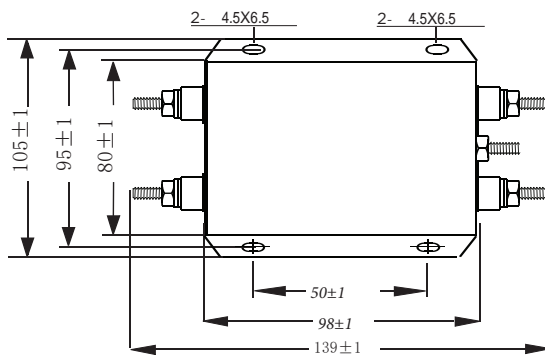

BED外壳样式：BED Case Styles

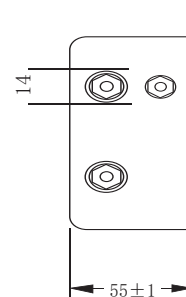
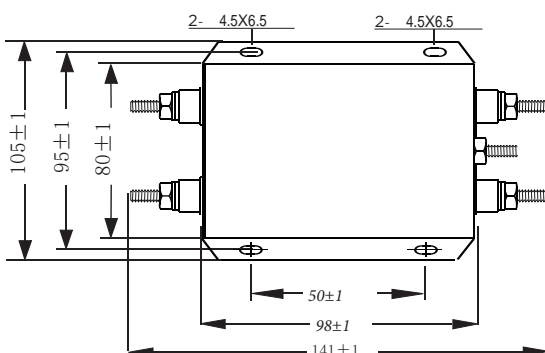

ZYH-B系列军工EMI电源滤波器
ZYH-B series military EMI filter

B系列：B Series

外壳样式：Case Styles

BEY外壳样式：BEY Case Styles

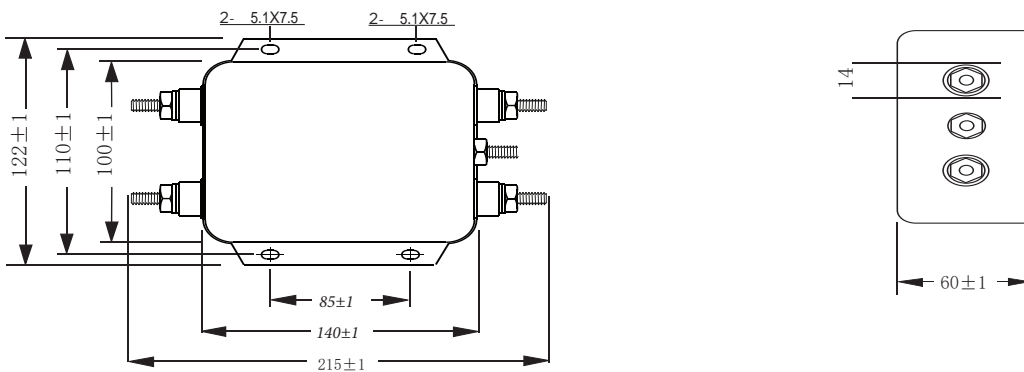

BEU外壳样式：BEU Case Styles

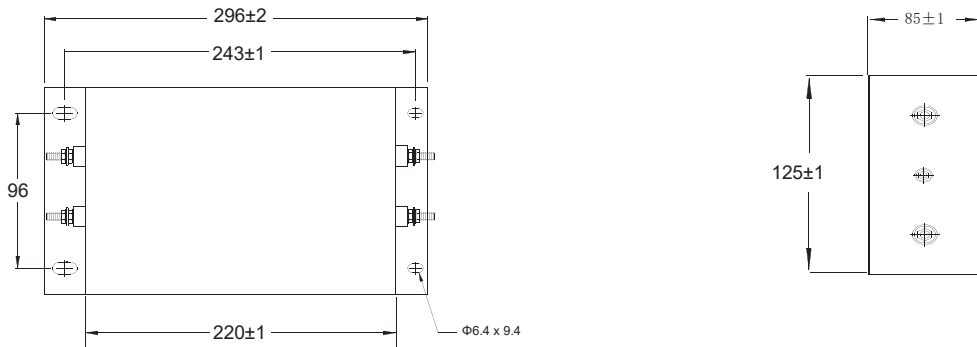

BEJ外壳样式：BEJ Case Styles

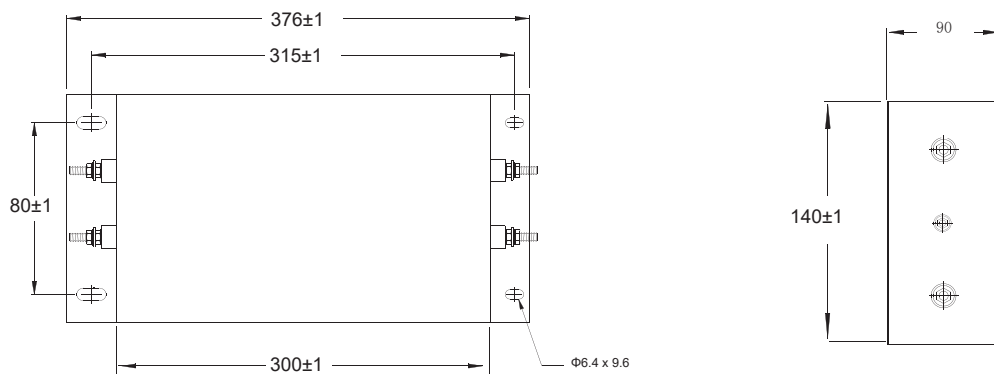

ZYH-B系列军工EMI电源滤波器
ZYH-B series military EMI filter

B系列：B Series

性能参数

Performance Data

典型插入损耗

Typical Insertion Loss

在封闭的50欧姆系统中测量

Measured in closed 50 Ohm system

- 共模/不对称 (L-G)
Common Mode / Asymmetrical (L-G)
- 差模/对称 (L-L)
Differential Mode / Symmetrical (L-L)

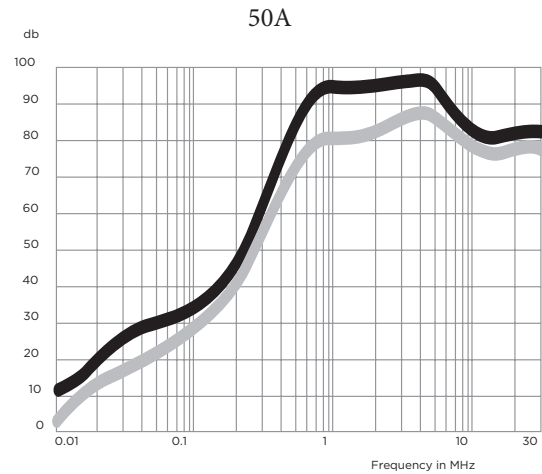
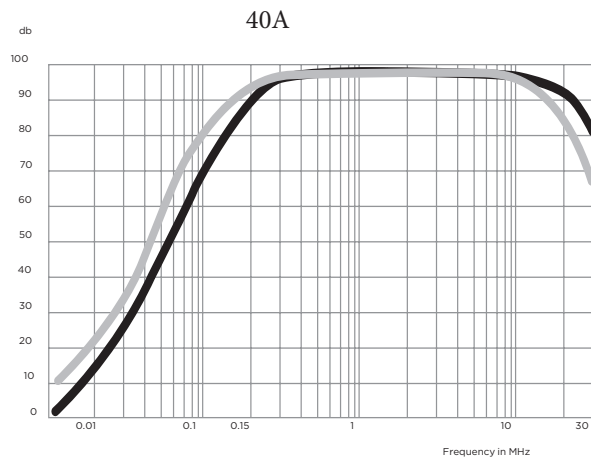
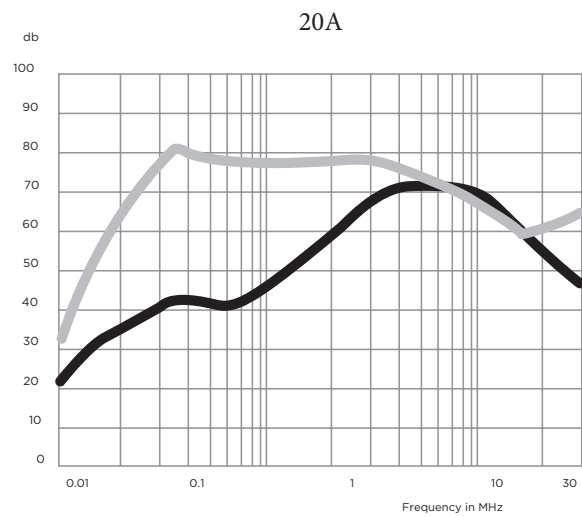
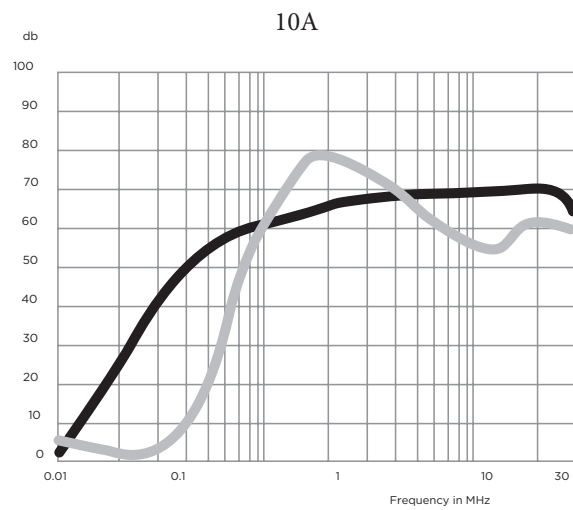

ZYH-B系列军工EMI电源滤波器
ZYH-B series military EMI filter

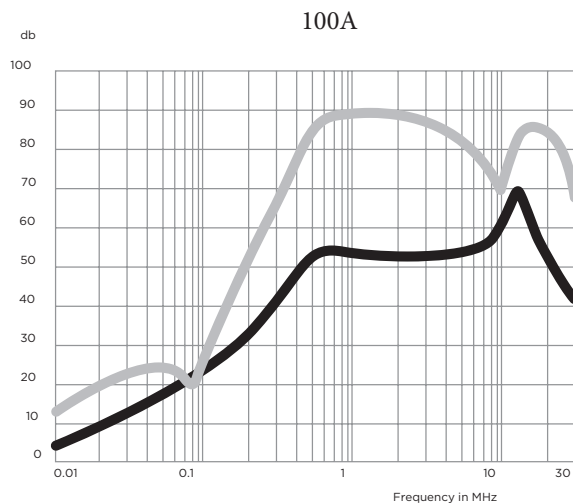
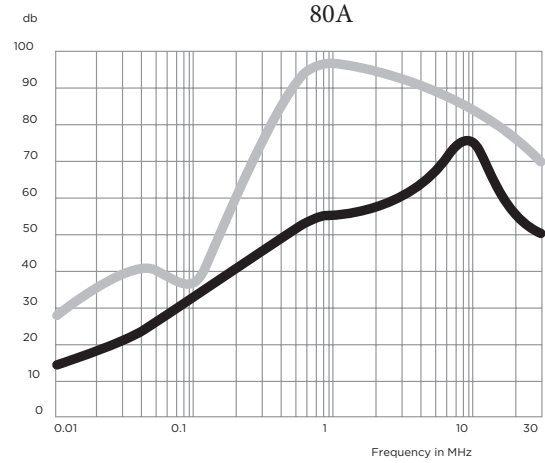
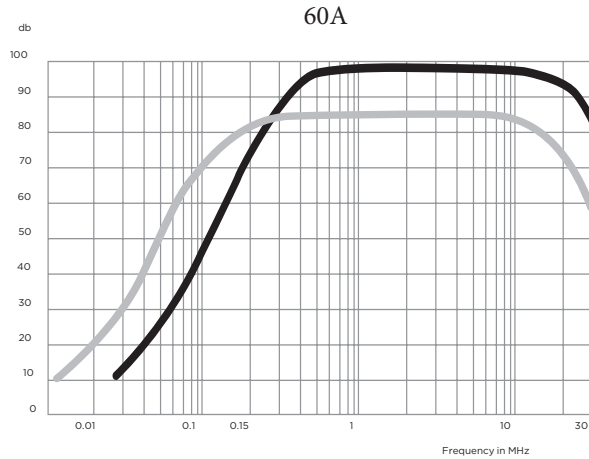

最小插入损耗 Minimum Insertion Loss

共模/不对称 (线对地)
Common Mode / Asymmetrical (Line to Ground)

差模/对称 (线对线)
Differential Mode / Symmetrical (Line to Line)

Current Rating	Frequency – MHz					
	.15	.5	1	5	10	30
VR Models						
10A	5	44	60	65	65	60
20A	5	48	60	68	68	48
40A	5	44	60	65	65	60
50A	5	44	60	65	65	60
60A	5	44	60	65	65	60
80A	5	44	60	65	65	60
100A	22	40	43	45	50	30

Current Rating	Frequency – MHz					
	.15	.5	1	5	10	30
VR Models						
10A	10	50	55	60	53	44
20A	72	75	78	70	66	68
40A	-	-	35	60	53	44
50A	-	-	35	60	53	44
60A	-	-	35	60	53	44
80A	-	-	35	60	53	44
100A	16	30	65	65	57	50