

ZYH-3XB系列三相三线差模增强型EMI电源滤波器
ZYH-3XB series three phases three wires high insertion loss EMI filter



ZYH-3XB 系列: ZYH-3XB Series

特点和应用: Features and Applications

极佳的低频衰减特性, 具有良好的共模和差模干扰抑制特性
High attenuation to low frequency, excellent performance of common mode and differential mode interference suppression

宽范围的衰减特性

Broadband attenuation characteristics 较小的泄漏电流

Low leakage current

适用于数据处理系统、电信系统和工业控制装置中的高性能电源滤波
Available for digital systems, telecom systems and industrial installations.

订购信息: Ordering Information

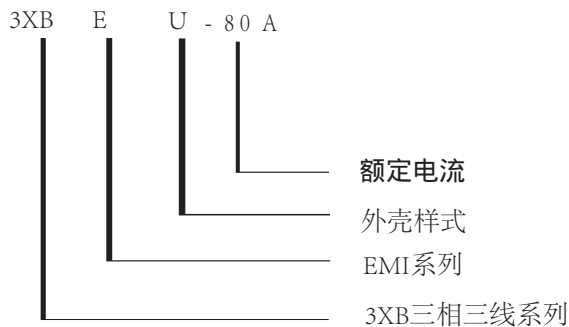

规格: Specifications

每条线路对地的最大泄漏电流:

Maximum leakage current each Line to Ground:

	3XBEU	3XBEJ	3XBET
@250VAC 60Hz:	≤3.0mA	≤4.0mA	≤6.0mA
@380VAC 50 Hz:	≤4.5mA	≤6.5mA	≤8.0mA

Hipot额定值 (一分钟):







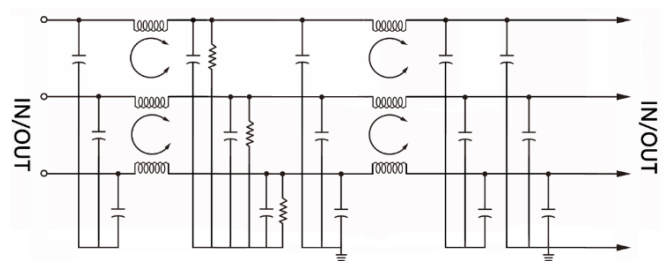



Hipot rating (one minute):

线路对地:	1850VAC
Line to Ground:	
线对线:	1500VDC
Line to Line:	
工作电压:	380VAC
Rated Voltage (max.):	
工作频率:	50/60HZ
Operating Frequency:	
额定电流:	0.5- 60A
Rated Current:	

电路原理图 Electrical Schematics



可选型号 Available Part Numbers

型号 Type ZYH-	额定电流范围 Rated Current (A)	绝缘电阻 Insulation Resistance	端接方式 Terminal	
			入Input	出Output
3XB EY	40	≥ 500		
3XBEU	50 - 80	≥ 500		
3XBEJ	80 - 200	≥ 500		
3XBET	200 - 400	≥ 500		
3XBET-B	400 - 1000	≥ 500		

ZYH-3XB系列：ZYH-3XB Series

外壳样式：Case Styles

3XBey 外壳样式：3XBey Case Styles

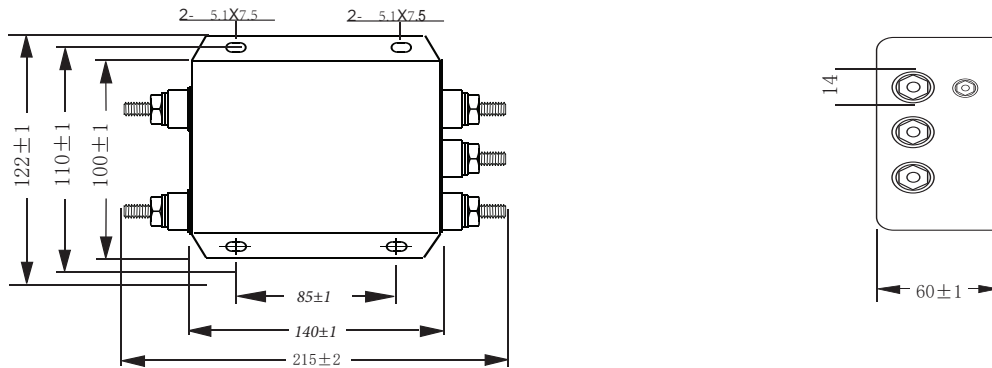

3XBey 外壳样式：3XBey Case Styles

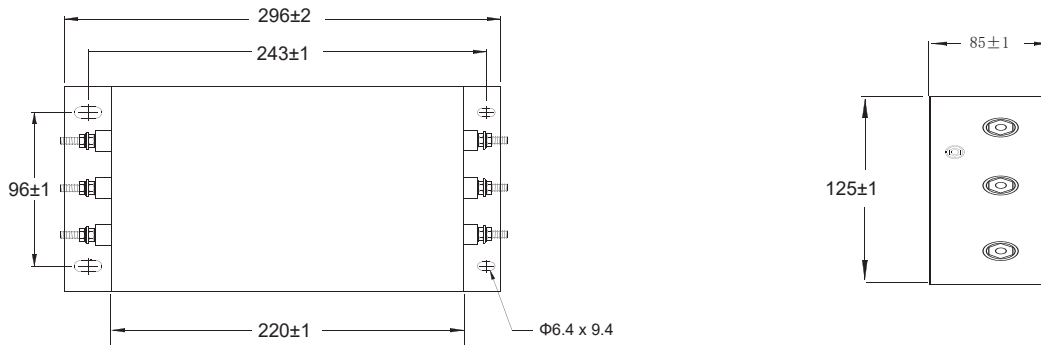

3XBey 外壳样式：3XBey Case Styles

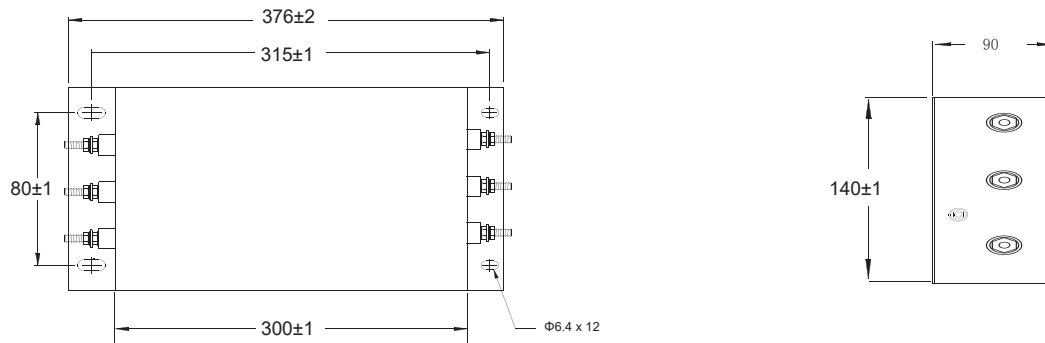

ZYH-3XB系列三相三线差模增强型EMI电源滤波器
ZYH-3XB series three phases three wires high insertion loss EMI filter

ZYH-3XB系列：ZYH-3XB Series

外壳样式：Case Styles

3XBET 外壳样式：3XBET Case Styles

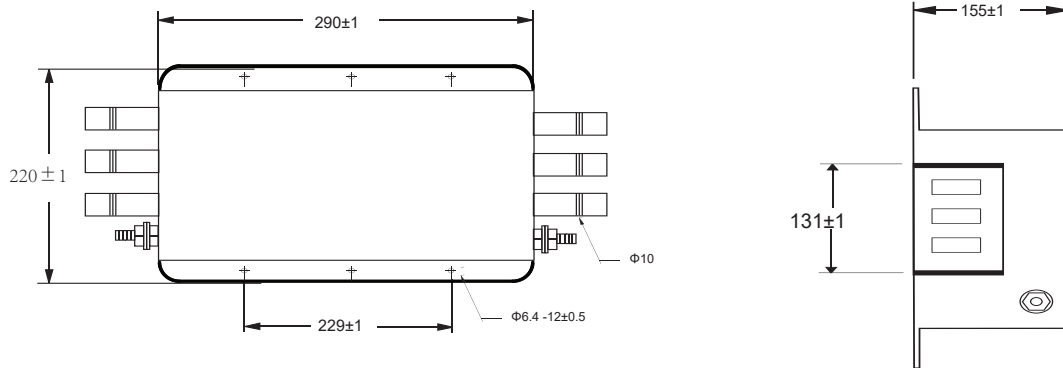

3XBET-B 外壳样式：3XBET -B Case Styles

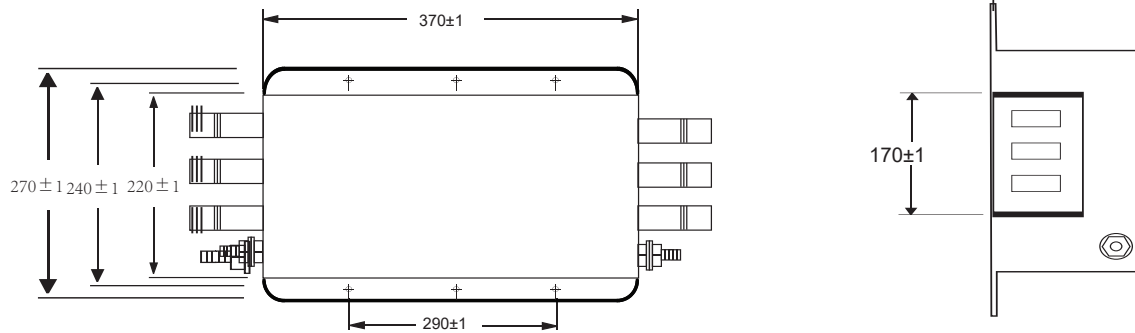

ZYH-3XB系列三相三线差模增强型EMI电源滤波器
ZYH-3XB series three phases three wires high insertion loss EMI filter

ZYH-3XB系列 : ZYH-3XB series

性能参数

Performance Data

典型插入损耗

Typical Insertion Loss

在封闭的50欧姆系统中测量

Measured in closed 50 Ohm system

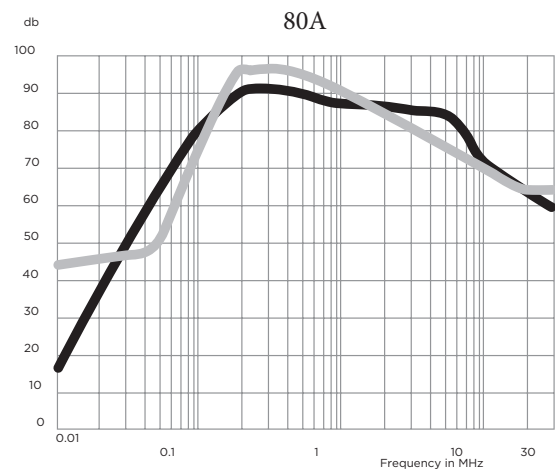
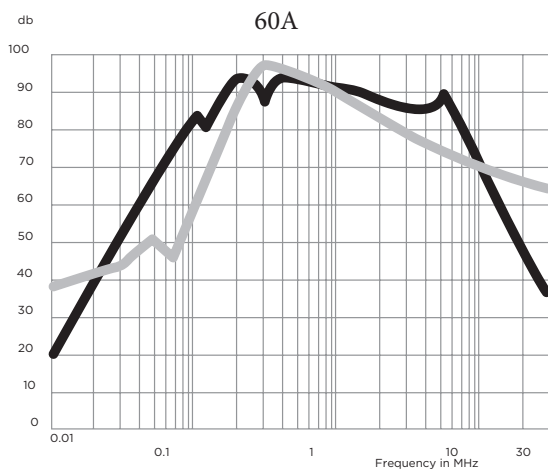
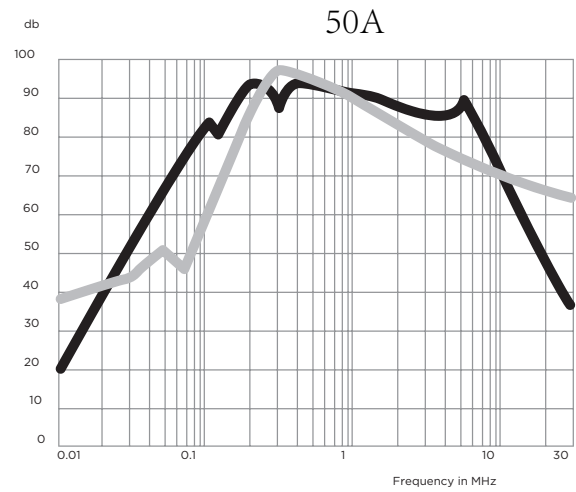
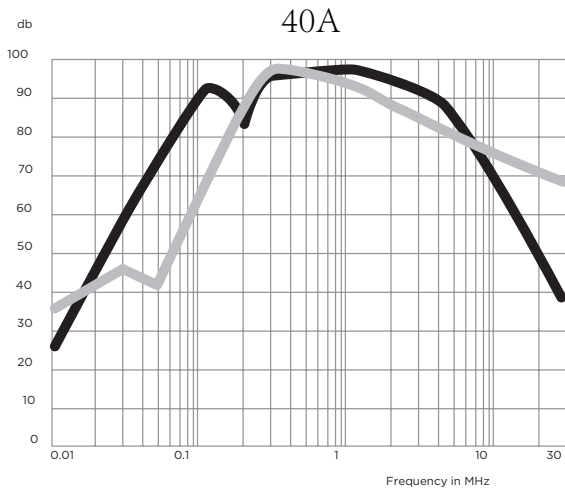

ZYH-3XB系列三相三线差模增强型EMI电源滤波器
ZYH-3XB series three phases three wires high insertion loss EMI filter

ZYH-3XB系列 : ZYH-3XB series

性能参数

Performance Data

典型插入损耗

Typical Insertion Loss

在封闭的50欧姆系统中测量

Measured in closed 50 Ohm system

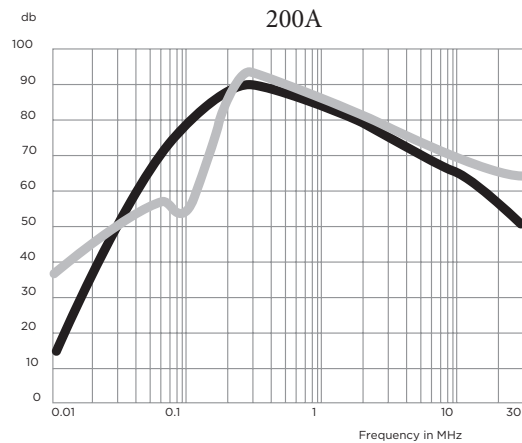
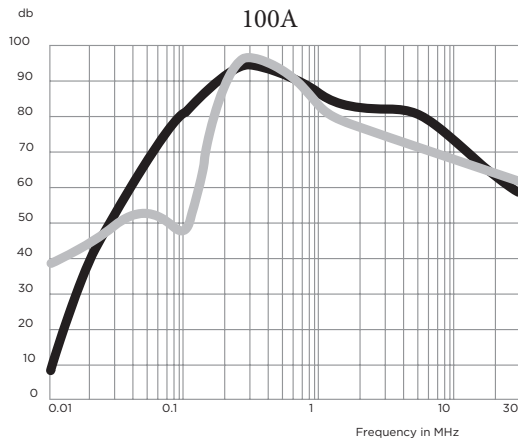

最小插入损耗 Minimum Insertion Loss

共模/不对称 (线对地)

Common Mode / Asymmetrical (Line to Ground)

Part No.	Frequency -MHz							
	.01	.05	.1	.5	1	5	10	30
60A	11	57	72	90	86	68	44	4
80A	10	57	75	84	77	75	62	45
100A	10	51	60	88	84	74	50	12
200A	-	50	57	82	79	75	51	7

差模/对称 (线对线)

Differential Mode / Symmetrical (Line to Line)

Part No.	Frequency -MHz							
	.01	.05	.1	.5	1	5	10	30
60A	27	45	41	84	77	63	61	43
80A	37	42	67	87	80	66	60	50
100A	27	35	39	75	72	51	44	31
200A	28	37	42	74	67	52	45	30