

ZYH-E系列 (10A以上) EMI电源滤波器
ZYH-Eseries (above10A) EMI filter

ZYH-E系列 (10A以上) :
ZYH-E Series (above10A)



E系列 : E Series

特点和应用: Features and Applications

适用于抑制电网及开关电源所产生的噪音和高频谐波
Applicable to suppressing noise and high frequency harmonic in power

较高的插入损耗, 较小的泄露电流
Low leakage current with high insert lose of noise

能有效地抑制线与线, 线与地之间的EMI噪音干扰
Control EMI interference between line to line, line to ground

小型电子设备和电子测量仪器、模块电源
Mini-electronic equipments and measuring instruments、module power supply

订购信息: Ordering Information

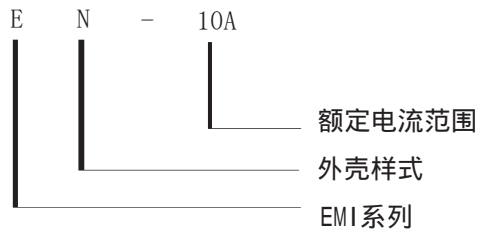

可选型号 Available Part Numbers

型号 Type ZYH-	额定电流范围 Rated Current (A)	绝缘电阻 Insulation Resistance	端接方式 Terminal	
			入Input	出Output
EB	10-20	≧ 500		
EN	10-20	≧ 500		
EM	10-20	≧ 500		
EK	10-30	≧ 500		
ES	10-30	≧ 500		
ER	40-60	≧ 500		
EY	60-80	≧ 500		
EU	80-100	≧ 500		
EJ	100 - 300	≧ 500		

规格: Specifications

每条线路对地的最大泄漏电流:
Maximum leakage current each Line to Ground:

@ 250 VAC	EB	EN	EM	EK
50 /60Hz:	≦ 0.3mA	≦ 0.3mA	≦ 1.0mA	≦ 1.5mA

@ 250 VAC	ES	ER	EY	EU	EJ
50 /60Hz:	≦ 2.0mA	≦ 2.0mA	≦ 2.5mA	≦ 4mA	≦ 4.5mA

Hipot额定值 (一分钟):

Hipot rating (one minute):

线路对地: Line to Ground:	1800VAC
线对线: Line to Line:	1500VDC
工作电压: Rated Voltage (max.):	250VAC
工作频率: Operating Frequency:	50/60HZ
额定电流: Rated Current:	10-300A
气候类别: Climatic Category	25/085/21

电路原理图Electrical Schematics

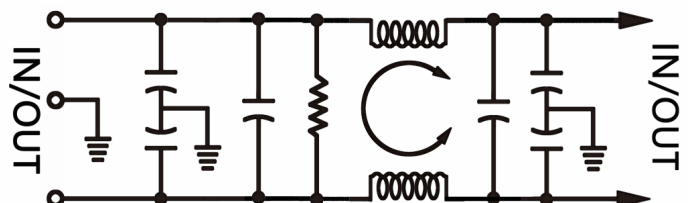

ZYH-E系列 (10A以上) EMI电源滤波器
ZYH-Eseries (above10A) EMI filter

ZYH-E系列 (10A以上) :
ZYH-E Series (above10A)

外壳样式 : Case Styles

EB外壳样式 : EB Case Styles

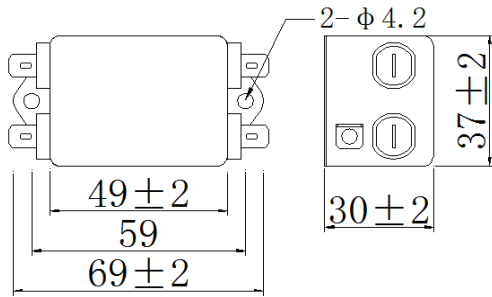

EN外壳样式 : EN Case Styles

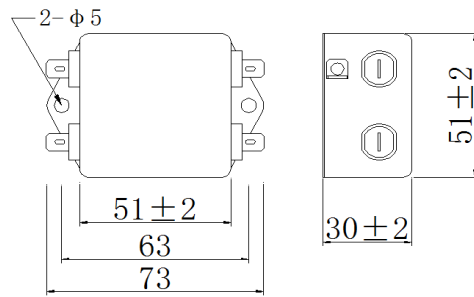

EM外壳样式 : EM Case Styles

样式1 : Case Styles One

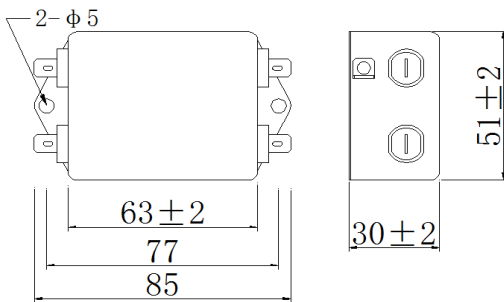

样式2 : Case Styles Two

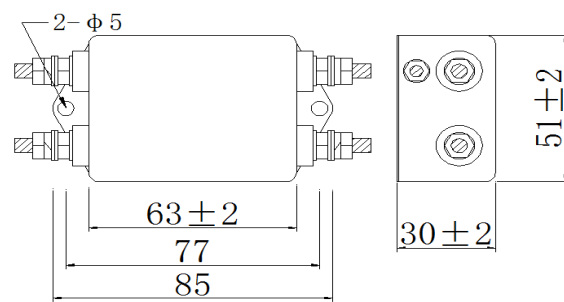

样式3 : Case Styles Three

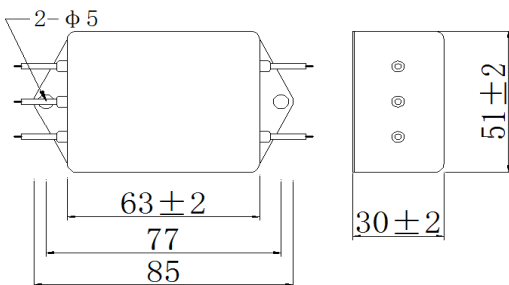

EK外壳样式 : EK Case Styles

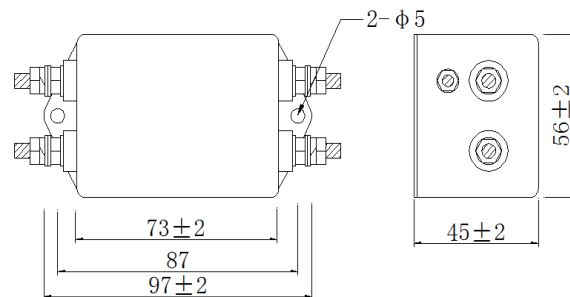

ES外壳样式 : ES Case Styles

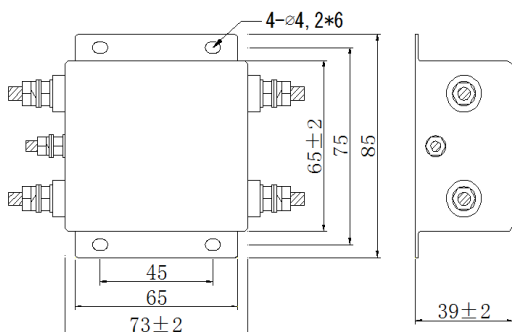

ER外壳样式 : ER Case Styles

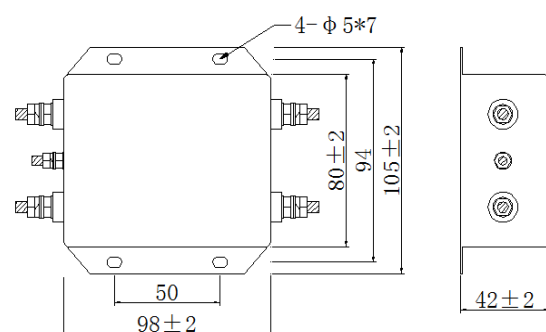

ZYH-E系列 (10A以上) EMI电源滤波器
ZYH-E series (above 10A) EMI filter

ZYH-E系列 (10A以上) :
ZYH-E Series (above 10A)

外壳样式 : Case Styles

EY外壳样式 : EY Case Styles

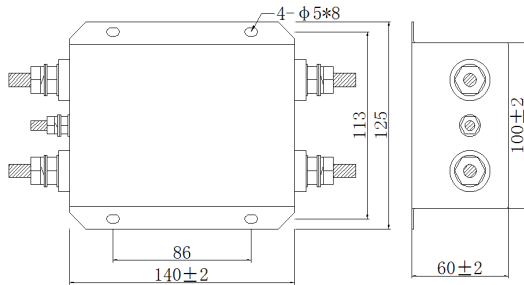

EU外壳样式 : EU Case Styles

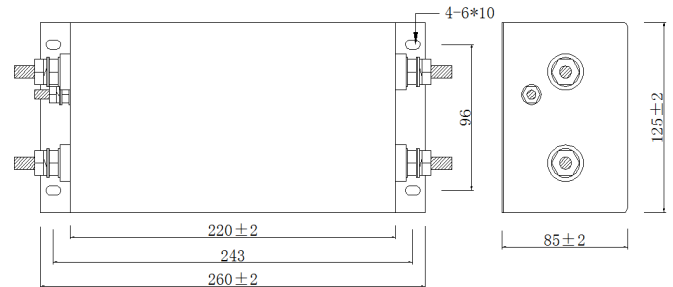

EJ外壳样式 : EJ Case Styles

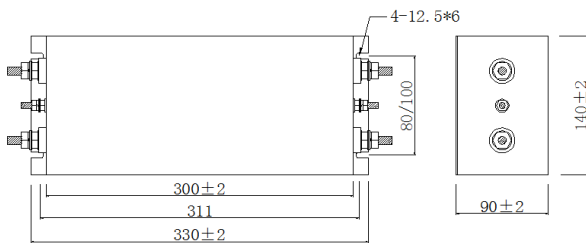

ZYH-E系列 (10A以上) EMI电源滤波器
ZYH-Eseries (above10A) EMI filter

ZYH-E系列 (10A以上) :
ZYH-E Series (above10A)

性能参数

Performance Data
典型插入损耗

Typical Insertion Loss
在封闭的50欧姆系统中测量

Measured in closed 50 Ohm system

— 共模/不对称 (L-G)
Common Mode / Asymmetrical (L-G)
— 差模/对称 (L-L)
Differential Mode / Symmetrical (L-L)

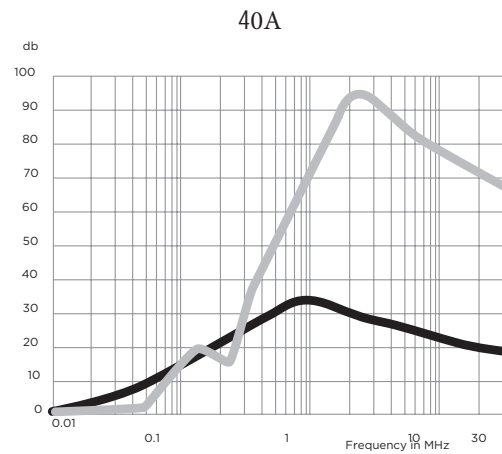
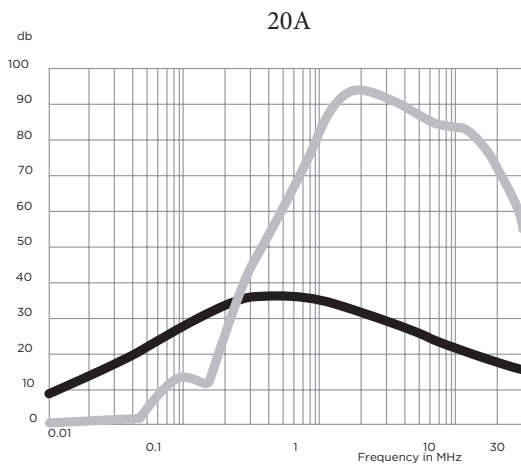
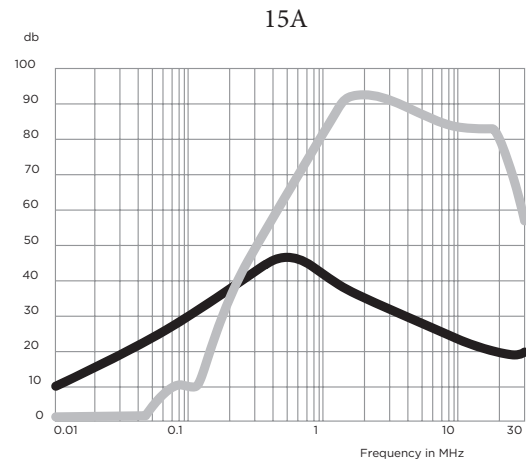
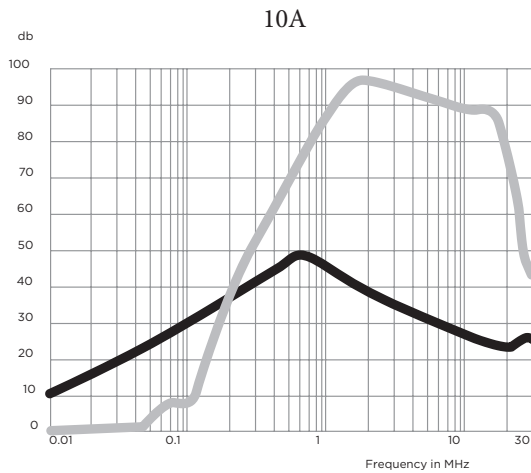

ZYH-E系列 (10A以上) EMI电源滤波器
ZYH-Eseries (above10A) EMI filter

ZYH-E系列 (10A以上) :
ZYH-E Series (above10A)

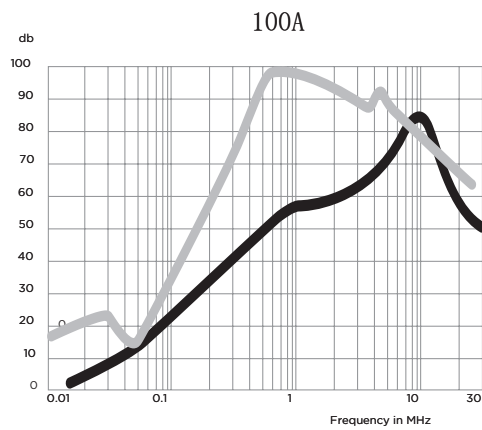
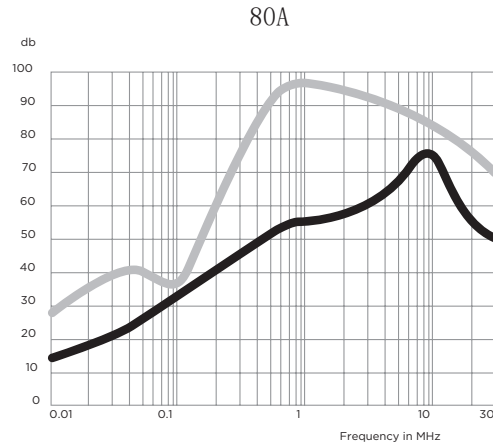
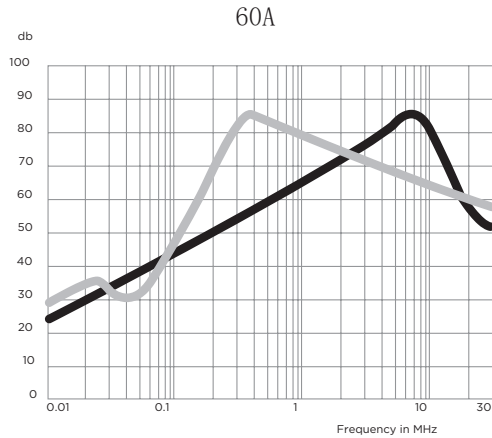

最小插入损耗 Minimum Insertion Loss

共模/不对称 (线对地)
Common Mode / Asymmetrical (Line to Ground)

Part No.	Frequency – MHz								
	.01	.05	.1	.15	.5	1	10	30	
10A	7	21	25	31	43	40	26	21	14
15A	7	27	27	30	43	37	24	17	12
20A	5	19	24	28	31	29	14	9	4
30A	-	5	11	14	27	30	20	17	14
60A	22	31	43	45	51	65	70	80	52
80A	22	31	43	45	51	65	70	80	49
100A	22	31	43	45	51	57	70	82	50

差模/对称 (线对线)
Differential Mode / Symmetrical (Line to Line)

Part No.	Frequency – MHz								
	.01	.05	.1	.15	.5	1	5	10	30
10A	-	-	4	21	63	80	80	74	36
15A	-	-	-	75	51	77	80	74	48
20A	-	-	11	9	54	77	74	69	47
30A	-	-	13	14	47	67	76	70	58
60A	27	39	42	35	80	97	90	84	58
80A	27	39	42	35	80	97	90	84	69
100A	27	39	42	35	80	97	90	84	65